

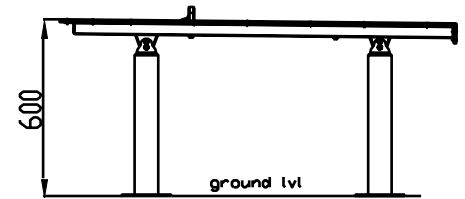

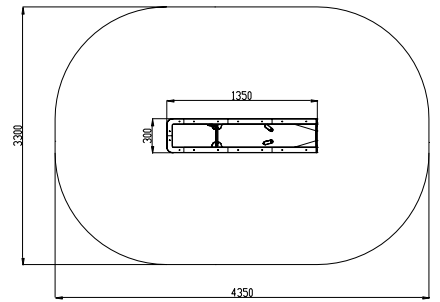

# JUEGOS DE AGUA - CANAL

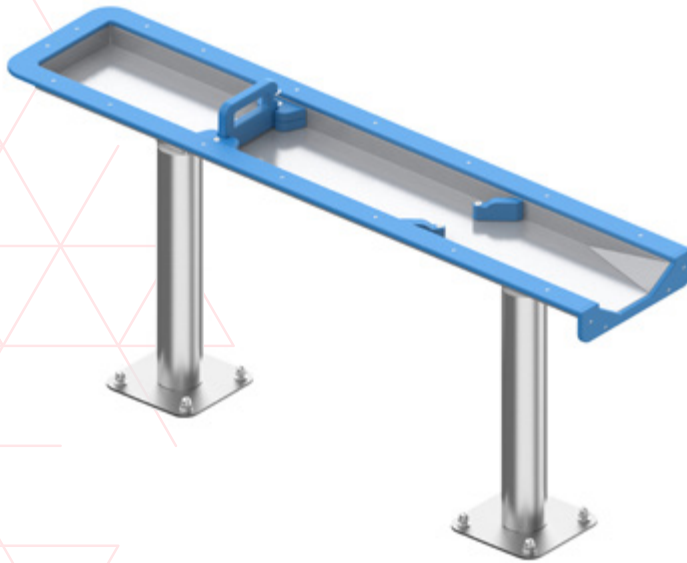





PDS\_570.203.010



Benelux



-  **570.203.010.011** aqua-mud factory - 'Channel' - blue - flat anchor
-  **570.203.010.012** aqua-mud factory - 'Channel' - blue - concrete anchor
-  **570.203.010.041** aqua-mud factory - 'Channel' - lime green - flat anchor
-  **570.203.010.042** aqua-mud factory - 'Split Channel' - lime green - concrete anchor

	 pcs	 pcs			 pcs		
<b>570.203.010.</b>	tbc	× 1	tbc cm	tbc			



**CHANNEL**

- HDPE panel 10 mm
- construction made of grinded stainless steel
- can be combined with other modules
- moveable and functional elements

**KANAL**

- HDPE Platte 10 mm
- Konstruktion aus geschliffenem Edelstahl
- kann mit anderen Modulen kombiniert werden
- bewegliche und funktionelle Elemente

**KANAAL**

- HDPE paneel 10 mm
- constructie van geslepen RVS
- geschikt voor combinatie met andere modules
- beweegbare en functionele onderdelen

**CANAL**

- panel HDPE 10 mm
- construido en acero inoxidable molido
- puede combinarse con otros módulos
- elementos móviles y funcionales

**CANAL**

- panneau en PEHD 10 mm
- construction en acier inoxydable broyé
- peut être combiné avec d'autres modules
- éléments mobiles et fonctionnels

**RYNNA**

- panel HDPE o grubości 10 mm
- konstrukcja zrobiona ze szlifowanej stali nierdzewnej
- możliwość zestawienia z innymi modułami
- ruchome i funkcjonalne elementy

MANUAL  
**M570.203**

STATUS  
**STD**

DIMENSIONS  
**135 × 30 × 60 mm**

